



# CRY8124

## Acoustic Imaging Camera

### User Manual



# Table of Contents

<b>01</b>	<b>User Notice</b>	<b>05</b>
<b>02</b>	<b>Introduction</b>	<b>07</b>
<b>03</b>	<b>Glossary</b>	<b>08</b>
<b>04</b>	<b>Product and Accessories</b>	<b>11</b>
<hr/>		
4.1	Product accessory list	11
4.2	Battery and charging	11
<b>05</b>	<b>Product Instruction</b>	<b>13</b>
<hr/>		
5.1	Appearance	13
5.2	Port	14
5.3	Power on the camera	15
5.4	Power off the camera	15
5.5	Sleep	15
<b>06</b>	<b>Software Function</b>	<b>17</b>
<hr/>		
6.1	Main interface	17
6.2	Interface operation	18
6.3	Display interface	19
6.4	Scene	19



6.5	Frequency	23
6.6	Function settings	23
6.7	Photos	26
6.8	Custom tools	27
6.9	Dropdown menu	28
6.10	System settings	28

## **07 Usage Tips 33**

---

7.1	Capturing sound source	33
7.2	Eliminating reflection interference	33
7.3	Eliminating interference noise	33
7.4	Equipment maintenance	33

## **08 Contact Us 34**

---

8.1	Hangzhou headquarters	34
8.2	Dongguan branch	34
8.3	Houston Office	34



# Revision History

Revision number	Description	Revision date
1.0	● Initial version	2024/04/19
1.1	● Add description	2024/07/19



# 01 User Notice

## Legal disclaimer

Copyright © 2024 Hangzhou CRY SOUND Electronic Co., Ltd. All rights reserved. This manual, including its text, images, graphics, and other content, is the property of Hangzhou CRY SOUND Electronic Co., Ltd. or other authorized companies. Without written permission, no entity or individual may excerpt, reproduce, translate, or modify this manual in any way. Hangzhou CRY SOUND Electronic Co., Ltd. does not provide any express or implied statements or warranties.

## Compliance

This device has been tested and complies with regulations regarding electronic products. It may cause interference to RF receivers in residential areas, and users are responsible for resolving such interference. The device is equipped with the CE mark, indicating compliance with relevant EMC requirements.

This device complies with the limits for Class A electronic devices specified in Part 15 of the FCC Rules. The device generates, uses, and radiates radio frequency energy. If not installed and used in accordance with the instructions, it may cause interference to radio communications. This manual serves solely as a guide for the specific model of the product and may differ from the actual product. Please refer to the physical product itself for accurate information and specifications.

In the event of product version upgrades or other requirements, CRY SOUND may update this manual. The latest version of the manual can be viewed on the device itself or accessed on the official website of CRY SOUND.

## Warranty and calibration

This product is covered by a free warranty repair service for abnormalities or malfunctions within two years from the date of purchase. The free warranty repair service does not cover issues caused by improper use or accidental damage such as drops. Unauthorized disassembly of the product will void warranty.

In case of malfunctions caused by improper use or accidental damage, we offer repair services at cost price. The device is calibrated during the manufacturing process. We recommend sending the device back to the manufacturer for calibration, testing, and maintenance every two years to ensure optimal performance during prolonged use.

## Safety usage reminder

To prevent potential fire or personal injury, please note:



1. Please carefully read the content of this safety notice before using the product.
2. Only use the product for its designated purpose.
3. Do not disassemble the device without authorization.
4. If the device experiences any malfunctions or abnormal heating, please stop using it.
5. Please contact the manufacturer for device repair services.
6. Do not place the device near heat sources, flames, or in high-temperature environments.

## **Limitations of the GHz frequency range**

According to Article 10(10) of Directive 2014/53/EU, as indicated in the packaging instructions, when selling this wireless radio equipment in Belgium (BE), Bulgaria (BG), Czech Republic (CZ), Denmark (DK), Germany (DE), Estonia (EE), Ireland (IE), Greece (EL), Spain (ES), France (FR), Croatia (HR), Italy (IT), Cyprus (CY), Latvia (LV), Lithuania (LT), Luxembourg (LU), Hungary (HU), Malta (MT), Netherlands (NL), Austria (AT), Poland (PL), Portugal (PT), Romania (RO), Slovenia (SI), Slovakia (SK), Finland (FI), Sweden (SE), Northern Ireland (UK), Turkey (TR), Norway (NO), Switzerland (CH), Iceland (IS), and Liechtenstein (LI), the wireless local area network (WLAN) function is restricted and limited to indoor use within the frequency range of 5150 to 5250 MHz.

This product includes Wi-Fi, Bluetooth, and GPS functionality. The wireless operating frequency bands include:

Bluetooth: 2402 MHz ~ 2480 MHz.

Wi-Fi: 2.400 GHz ~ 2.4835 GHz, 5.155.35 GHz, 5.475.725 GHz, 5.725~5.85 GHz.



## 02 Introduction

Introducing CRY SOUND's cutting-edge acoustic cameras, revolutionizing industrial inspections with advanced capabilities. The CRY8124 acoustic imaging camera excels at pinpointing leaks, identifying electrical partial discharge, and detecting mechanical deterioration, performing over 10 times faster than traditional methods.

In gas leak detection scenarios, the acoustic imaging camera can quickly pinpoint the location of gas leaks and estimate leakage volume and economic losses in real-time. In partial discharge detection applications, the acoustic imaging camera can display PRPD charts in real-time and accurately identify discharge types, aiding in informed decision-making.

The acoustic imaging camera utilizes microphone array beamforming technology to obtain sound source distribution data. It is coupled with a high-definition camera to capture real-time video footage. By combining the sound source distribution data with the video image, the device performs sound-image fusion, allowing the dynamic sound source status and position to be displayed in real-time on the device's screen.

Paired with sophisticated analysis software, CRY8124 assists users in analyzing, editing, and generating reports for audio, video, and image data. With visual tools and charts, users can intuitively grasp data, enabling them to make accurate judgments and decisions.



## 03 Glossary

### USB power delivery (USB PD)

The device utilizes a power delivery protocol based on the USB 3.0 standard, allowing for higher power transfer through the USB port.

### Sound pressure level (SPL)

The device measures the amplitude of the sound source using sound pressure level (SPL), which is a physical quantity that represents the magnitude of a sound wave. SPL is expressed in decibels (dB) and is referenced to a standard sound pressure level in air. It is commonly denoted as dBSPL when used for representation.

### Audible domain

The frequency range of sound that can be perceived by human ears generally refers to the sound in the frequency band of 20Hz-20KHz.

### Ultrasonic

Generally, refers to a frequency of more than 20kHz, which the human ear cannot perceive.

### Sound image

It refers to the two-dimensional data table representing the intensity distribution of sound sources in space, after the signal collected by microphone array is calculated by the algorithm.

### Palette

The color data used in the color mapping of a sound image.

### Sound cloud image

The sound pressure level data of each resolution point on the sound image is mapped to a certain color number on the palette, according to a certain conversion formula to form a color image. Then it is fused with the visible image to form a sound cloud image.

### Test frequency range





When a frequency range is selected within the full frequency range supported by the device, the device will only measure and display a sound cloud image that is within this frequency range. Sound outside this frequency range will not be displayed.

## Frequency peak

A peak in the spectrum denotes a strong sound energy distribution at this frequency.

## Dynamic range

The scale of the intensity of the sound source that can be shown on the sound cloud image.

## Field of view

An angle formed by the camera and the two diagonal points of the rectangular picture captured by it.

For sound cloud image, it is an angle formed by the microphone array and the two diagonal points of the rectangular sound image.

## General scenario

The general scenario represents the fundamental operational scenarios for the device. In these scenarios, the device possesses basic acoustic imaging capabilities, supporting time-domain analysis and spectrogram analysis. Additionally, when a thermal module is installed, users can view thermal images.

## Gas leak scenario

Gas testing scenario involves equipment being used to detect gas leaks in industrial settings, such as compressed air leaks and carbon dioxide leaks. In this scenario, besides time-domain analysis, spectrogram analysis, and viewing of thermal images, analysis can also be conducted on gas leak volume, economic losses, etc. During the playback of recorded images or videos, labels can be edited.

## Partial discharge scenario

Partial discharge scenario involves the detection of partial discharge in electrical equipment, such as surface discharge occurring along insulators. In this scenario, besides time-domain analysis, spectrogram analysis, and viewing of infrared images, analysis can also be conducted on acoustic signals, plotting into PRPD charts. This allows inspection personnel to quickly identify the type of PD.



## **Mechanical scenario**

Mechanical scenario involves the detection of mechanical anomalies causing ultrasound, such as damaged conveyors. In this scenario, besides time-domain analysis, spectrogram analysis, and viewing of infrared images, multiple frequency points and single frequency points can be set to analyze the tested equipment.



## 04 Product and Accessories

### 4.1 Product accessory list

Item numbers	Name	Description
1	Acoustic Imaging Camera	CRY8124
2	Power adapter	Power adapter for equipment charging.
3	USB-C charge cable	Cable used to charge the device or export data.
4	Headphones(optional)	Connecting equipment is used to monitor ultrasonic wave, etc.
5	Smart battery pack	Integrated LED battery indicator, a single charge lasts for 5 hours.
6	Thermal imaging camera module (optional)	IA1301(384*288 resolution), IA1302(640*512 resolution), compatible with CRY8124 device.
7	Smart battery charger	Charges 1 battery at a time. Lightweight, small size design.

### 4.2 Battery and charging

#### Battery information

The device is powered by a lithium-ion battery with a nominal capacity of 6600mAh at 7.2V. To charge the device, use the USB-C port labeled "USB-C" on the device. It is recommended to use a power adapter or portable charger that supports the PD (Power Delivery) protocol with a 9V voltage output and a minimum output power of 27W. Alternatively, you can use a charging kit that includes a charging dock, where the battery can be placed for charging.

#### Battery compliance

The battery has been tested and meets the requirements of the following standards:

1. Section 38.3 of the United Nations Manual of Tests and Criteria.
2. Complies with CE, FCC, and UKCA requirements.
3. Complies with CE-RoHs requirement.

#### Battery replacement

Battery replacement should follow these steps:

1. Rotate the lock latch of the battery cap to the "unlock" position to remove the battery cap. The battery cap is connected to the device shell with a lanyard.



2. Use your fingers to pinch the battery tongue and pull it outward to remove the battery.
3. Check the battery level. There are 5 LED battery level indicator lights on the battery (indicating 20%, 40%, 60%, 80%, and 100% battery levels). To check the battery level, press the "PUSH" button. The battery level indicator lights will light up. If all 5 indicator lights are lit, the battery level is 100%.
4. Insert the battery into the battery compartment. Ensure the battery tongue is aligned with the battery and place the lanyard above the battery cap. Insert the battery cap into the device and rotate the lock latch to the "locked" position. If the device's battery level is low, it will remind you to charge the device.

## Battery charging

### Charge the device using a USB-C cable

Connect one end of the USB-C cable to the USB1 port of the device and the other end to the USB-C adapter.

### Charge the battery using a smart battery charger

Insert the battery into the smart battery charger. Once the green charging indicator light starts flashing, it indicates that the charging has begun. Once the battery is fully charged, remove it from the smart battery charger.

## Attention

1. Please do not place the battery near heat sources, flames, or use it in high-temperature environments.
2. Please do not expose the battery to direct sunlight for extended periods or use the product under prolonged exposure to sunlight.
3. Please do not disassemble the battery without authorization.
4. Please do not charge the battery in high-temperature environments (exceeding 45 °C).
5. If the product malfunctions or shows any abnormalities, please stop using it and contact the manufacturer to schedule a repair.
6. Please do not exceed 24 hours of charging time for the battery.
7. If not in use for a prolonged period, please remove the battery and regularly charge it.
8. It is recommended to store the product within a temperature range of -20 °C to +40 °C. If the storage duration exceeds 2 months, please store the product in an environment with a temperature below 40 °C and remove the battery.



# 05 Product Instruction

## 5.1 Appearance

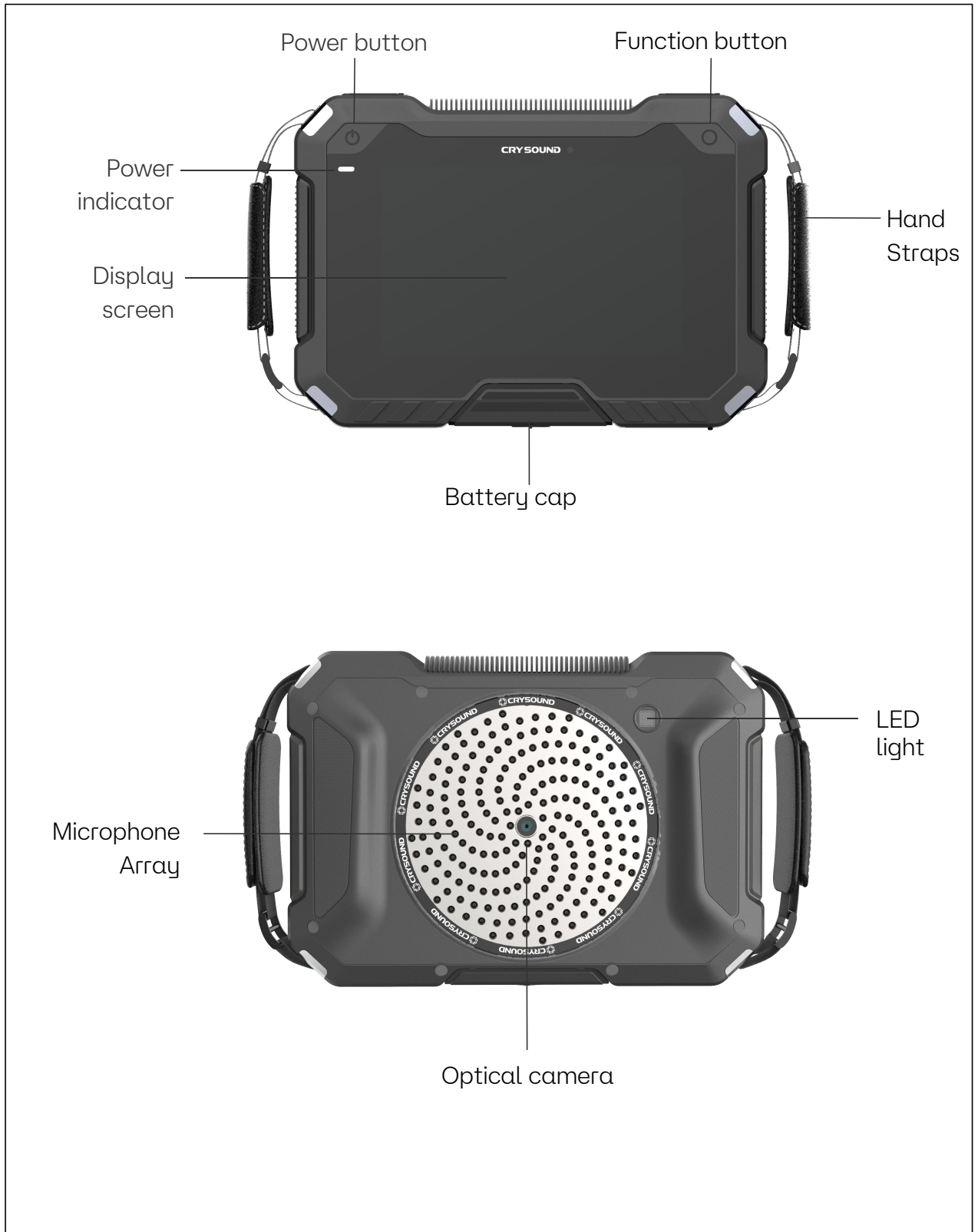

## 5.2 Port

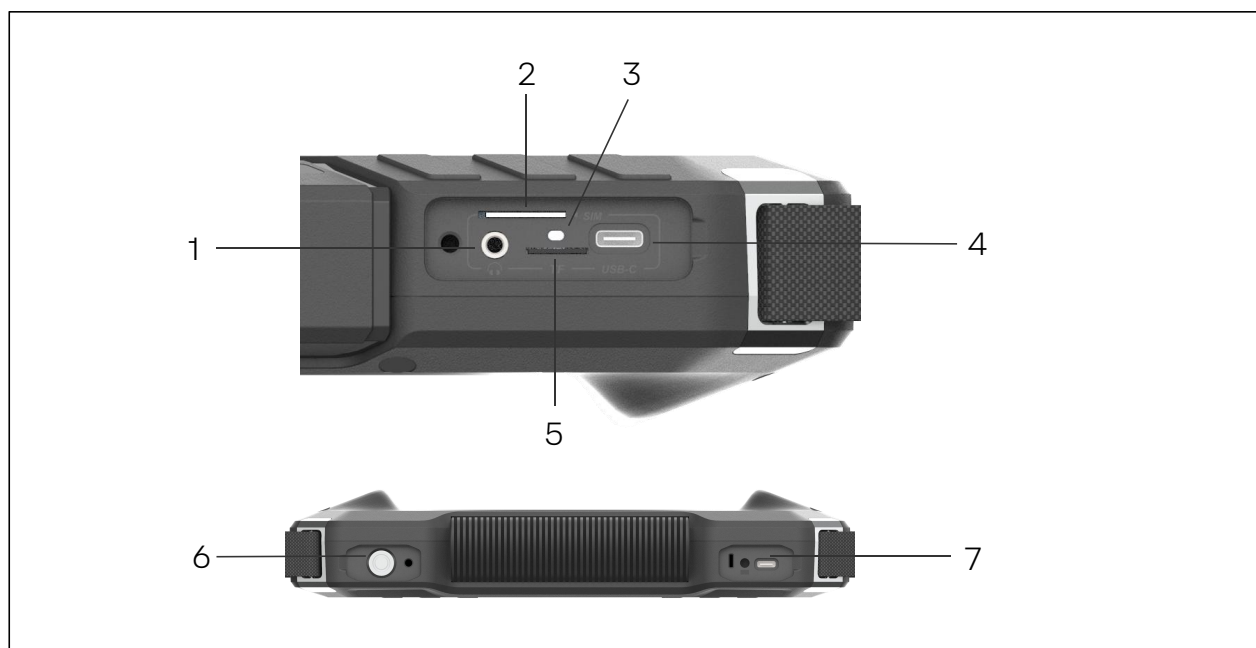

### 1 - 3.5mm audio jack

During the inspection test, insert a 3.5mm earphone, and you will be able to hear an audio representation of the ultrasonic signal.

### 2 - SIM card slot

Inserting the SIM card and enabling the mobile data function, you can upload data to the platform (supported by some models).

### 3 - Charging indicator light

After inserting the charger, the indicator light remains constant. Once the battery is fully charged, the indicator light will turn off.

### 4 - USB-C 1

You can charge the device using a USB-C data cable with a compatible charger. When connected to a computer via a USB-C cable, you can also export files or perform software upgrades. By using a USB-C to HDMI adapter and connecting it to a monitor, you can mirror the device's screen onto the display.

### 5 - TF card slot

Insert a TF card to store photos and videos captured by the camera.

### 6 - Analog input

After inserting the valve internal leakage sensor (supported by some models), you can test whether there is internal leakage in the pipeline. After inserting the vibration sensor, you can test the vibration displacement of mechanical equipment.

### 7 - USB-C 2

After inserting the thermal imaging camera module, the camera can display thermal images.

## 5.3 Power on the camera

When the battery is sufficiently charged, press and hold the "⏻" button for 5s until the power indicator lights up. After powering on, the camera will enter the testing interface.

**Note:** Before powering on, please ensure that the battery has sufficient charge. If the battery is low, please charge it promptly or replace it with a fully charged battery.

## 5.4 Power off the camera

### Power off manually

Long press the "⏻" button to mandatory shutdown the camera. Short press the "⏻" button to bring up the shutdown options, then click on "Shutdown" to turn off the camera.

### Auto power off

You can set the auto power-off time in the "System Settings" menu. Users can set the power-off time through the following steps:

1. Swipe down the menu bar from the top of the screen and tap "⚙️" to access "System Settings" - "Low energy Settings".
2. Enable automatic shutdown and set the desired time for automatic shutdown.
3. Tap "X" to save and exit.

**Note:** Automatic shutdown will only be triggered if automatic sleep mode is enabled.

## 5.5 Sleep

### Manual sleep

Short press the "⏻" button to bring up the options "Shutdown/Sleep/Cancel". Click on "Sleep" to put the camera into sleep mode. Short press the "⏻" button again to wake up the camera.

### Auto sleep

You can set the auto sleep time in the "System Settings" menu. Users can set the auto sleep time using the following steps:

1. Swipe down the menu bar from the top of the screen and tap "⚙️" to access "System Settings" - "Low energy settings".



2. Enable auto sleep and set the desired time for auto sleep.
3. Tap "X" to save and exit.

**Note:** Short press the "⏻" button to wake up the camera from sleep.





# 06 Software Functions

## 6.1 Main interface

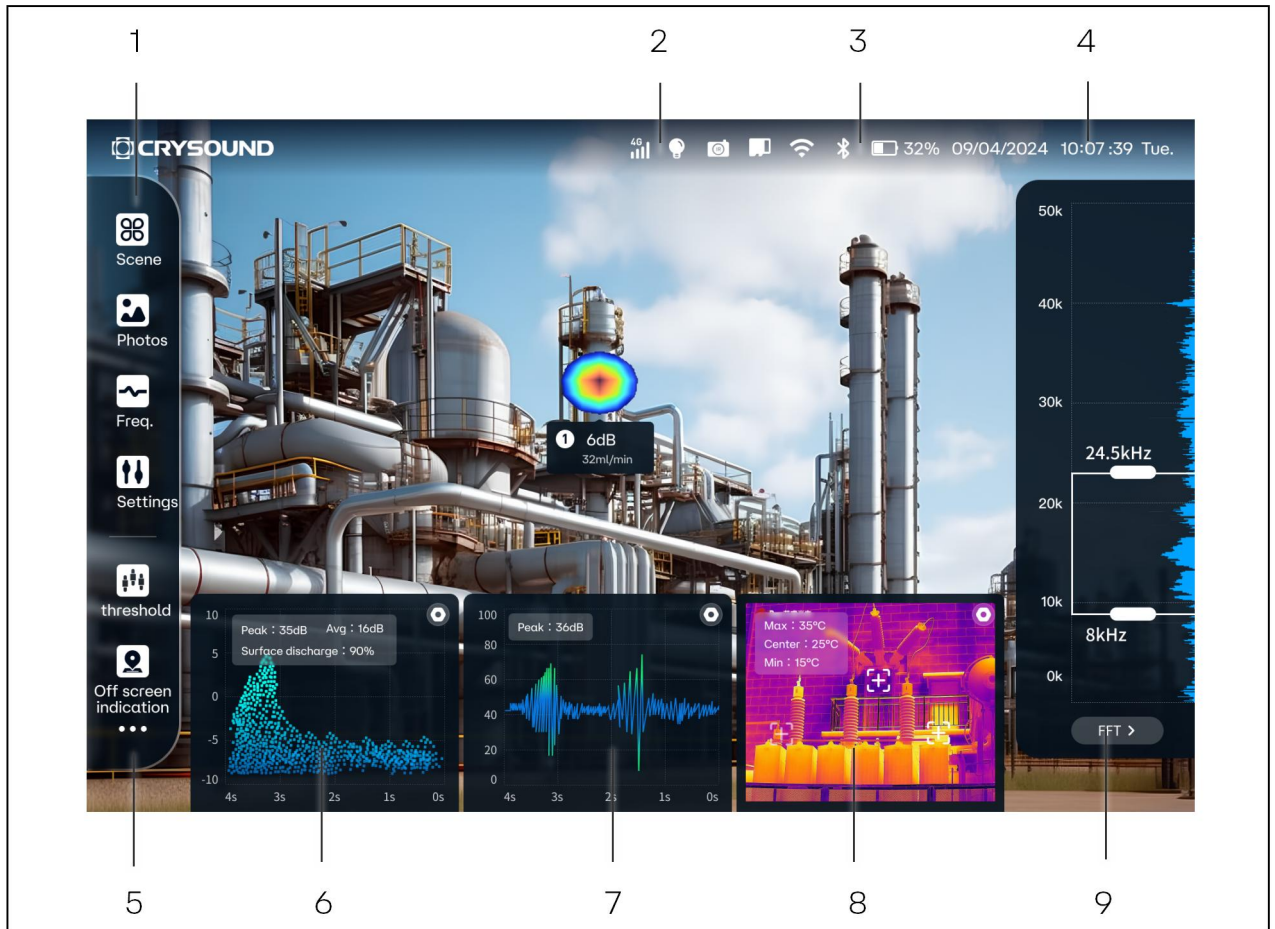

### 1 - Fixed buttons

Scene, Photos, Frequency, Settings.

### 2 - Dropdown menu

By pulling down the dropdown menu, you can access and customize various functions and open the system settings.

### 3 - Status bar

Displays the current working status of device functional modules.

### 4 - Time

Displays the current time of the camera.

### 5 - Customizable buttons

Users can customize the shortcut buttons.



### 6 - Chart 1

You can set up PRPD spectrogram, Time domain chart, Thermal image, Time-Frequency domain graph, and camera image.

### 7 - Chart 2

You can set up PRPD spectrogram, Time domain chart, Thermal image, Time-Frequency domain graph, and camera image.

### 8 - Chart 3

You can set up PRPD spectrogram, Time domain chart, Thermal image, Time-Frequency domain graph and camera image.

### 9 - Frequency selection box and FFT spectrogram

You can set the test sound frequency range and view the FFT spectrogram.

## 6.2 Interface operation

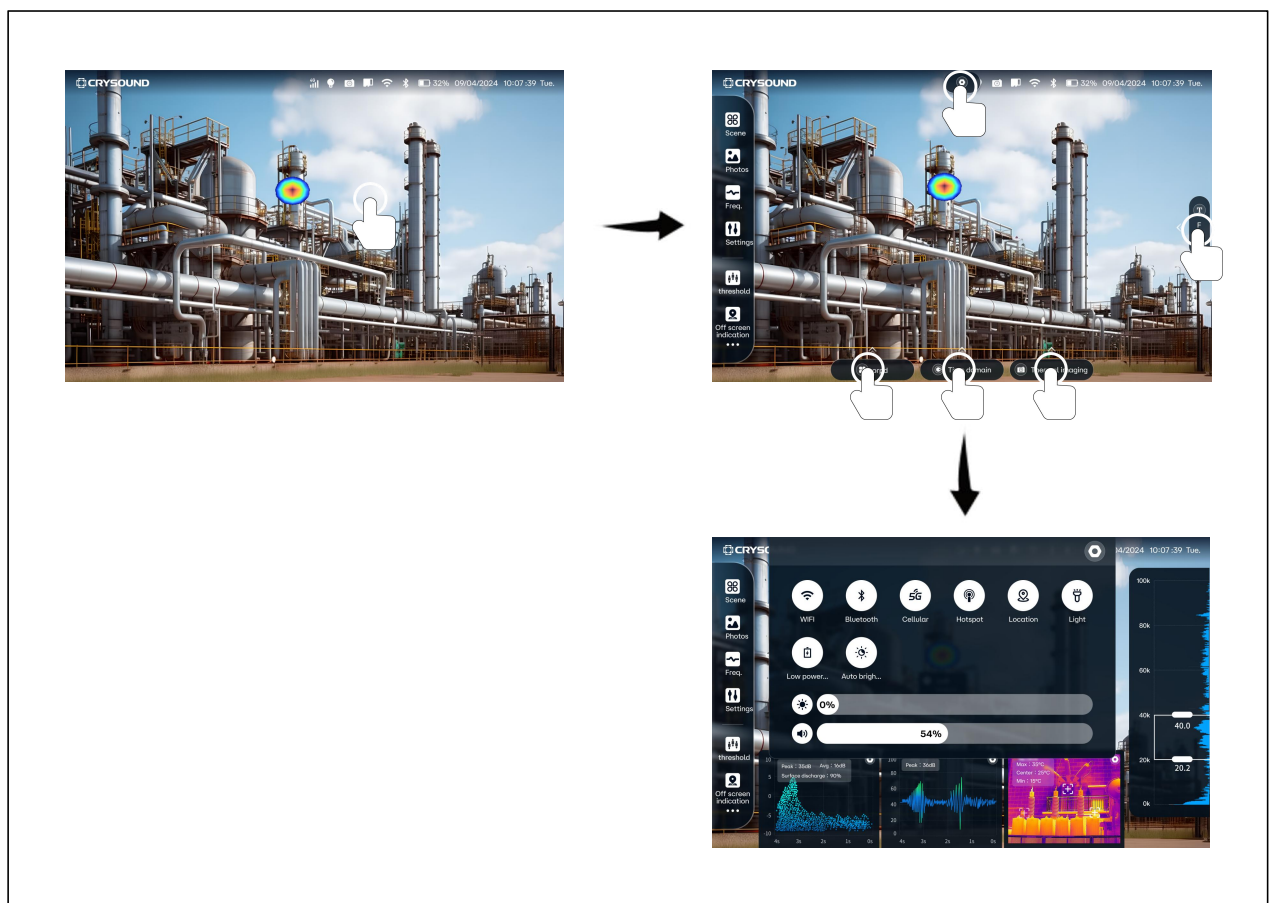

Clicking the video area brings up the spectrogram button. Clicking the "T" button brings up the FFT spectrogram. Clicking the "●" button brings up the dropdown menu.

Clicking the "☰" button can bring up the chart. Clicking the "●" button in the top right corner of the chart will bring up chart options, where you can choose between a



time-domain chart, spectrogram, and camera. If the thermal module is installed, you can also select the thermal image, and some modes support PRPD spectrum.

On the main interface, short-pressing the "📷" button captures a photo, while long-pressing the "📷" button for 2 seconds starts recording a video. Pressing the "📷" button again shortly stops the recording.

### 6.3 Display interface switching

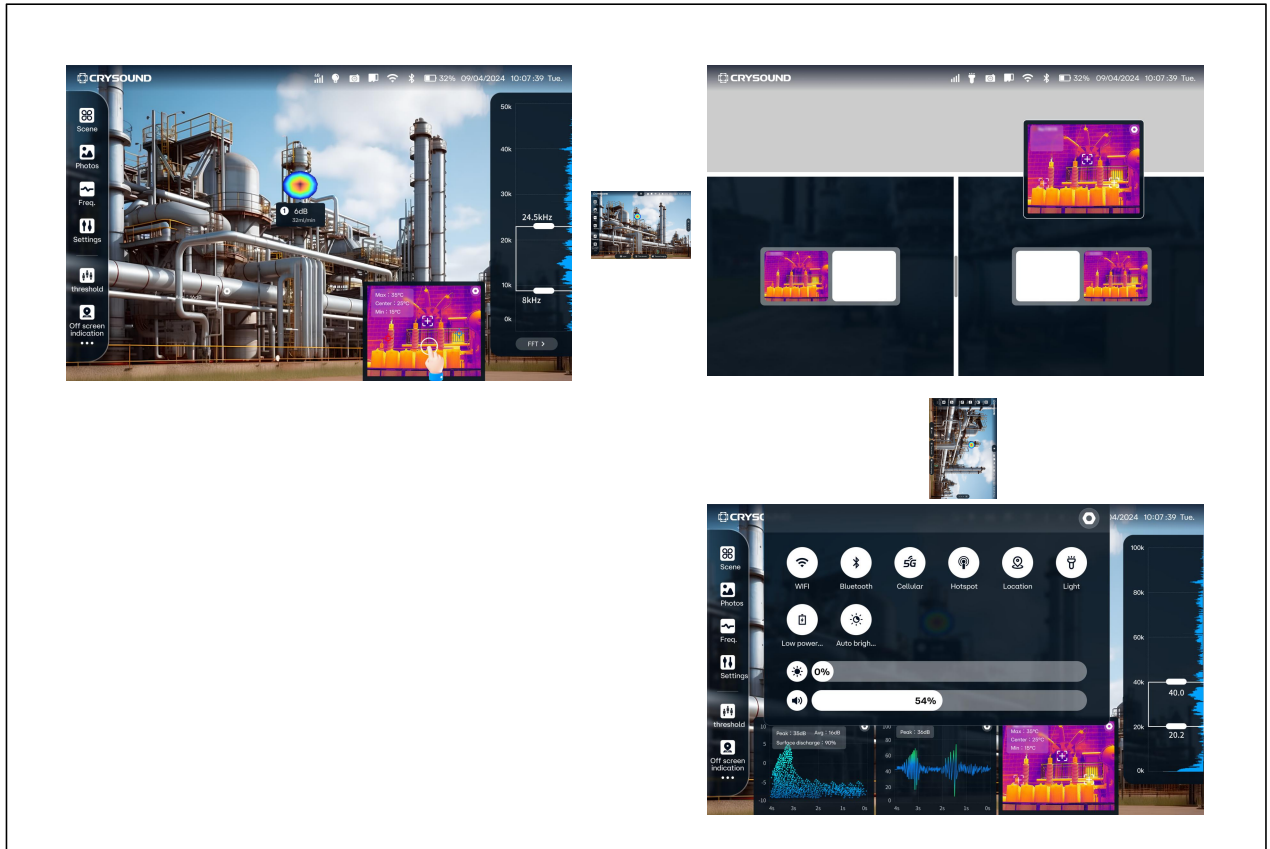

Long pressing the thermal image enters the dragging mode, allowing you to drag the thermal image to the upper area of the main screen to display it in the thermal view. Dragging the thermal image to the left or right area enters the split-screen display mode.

### 6.4 Scene

By clicking on the "Scene" button, users can select preset scenarios. The CRY8124 camera comes pre-set with four default scenarios, "General Scenario", "Gas Leak Scenario", "Partial discharge scenario", and "Mechanical Scenario". Additionally, users can customize other scenarios.

#### General scenario



When the camera is operating in the "General scenario", it can capture gas leaks, partial discharge, and other noise signals. It can also display the source location on the screen but does not have analysis capabilities.

On the main interface, clicking on "Function Settings" will take you to the function parameter settings page. In the "Acoustic Parameter" section, select "General".

## Gas leak scenario

When the camera is operating in the "Gas leak scenario", it can capture gas leakage signals and display the source location on the screen. It also can analyze the leakage volume for various gas types and different types of leakage points.

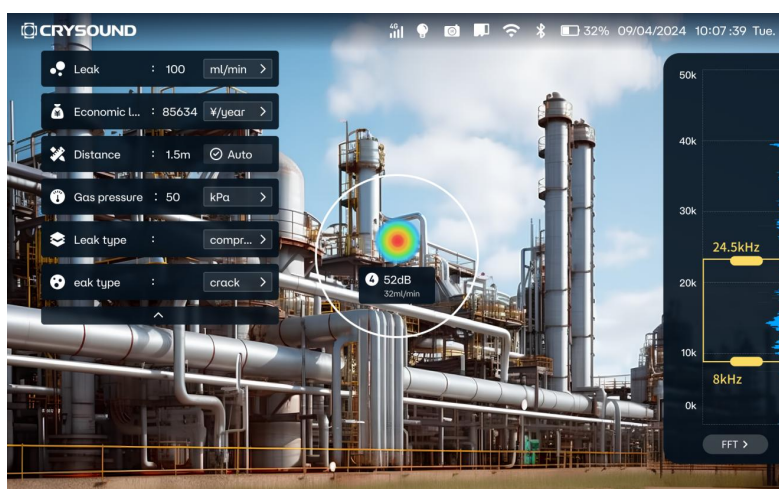

### Leak

Estimated gas leakage volume calculated by the algorithm.

### Cost

Estimated economic loss caused by the leakage based on the algorithm.

### Distance

Distance between the gas leak point and the camera. When "Auto" is checked, the algorithm will calculate the distance (less than 3m). If "Auto" is not checked, you need to input the distance value manually.

### Pressure

Manually input the gas pressure for more accurate leakage volume calculation.

### Gas

Users can select the gas type from options, such as "Air", "Carbon Dioxide", "Nitrogen", "Argon", "Hydrogen", and "Oxygen" based on the gas type being tested.

### Hole



Users can choose from five types: Connector, Flange, Weld, Thread, and Hole, to match the corresponding leakage point type for more accurate leakage volume testing.

On the main interface, clicking on "Function Settings" will take you to the function parameter settings page. In the "Acoustic Parameter" section, select "Gas".

### **Gas type**

Same as the gas type on the main interface.

### **Gas pressure**

Same as the gas pressure on the main interface.

### **Leak type**

Same as the leakage point type on the main interface.

### **Leak unit**

The unit for measuring leakage rate can be set to "mL/s", "mL/min", "L/min", "L/h", "CFM", "CCM".

### **Ratio of power to flow rate**

Users can set the ratio of power to flow rate for calculating economic losses.

### **Cost of gas**

Users can set the cost of gas for calculating economic losses.

### **Cost of electricity**

Users can set the cost of energy consumption per unit, used for calculating economic losses.

### **Operating hours**

Users can set the total annual leakage duration for calculating economic losses.

### **Currency**

The exchange rate relative to the US dollar can be modified.

### **Advanced settings**

When users click on "Advanced Settings", advanced setting parameters will pop up.

## **Partial discharge scenario**



When the camera is operating in the "Partial discharge scenario", it can capture partial discharge signals and display the source location on the screen. It also has PRPD analysis capabilities.

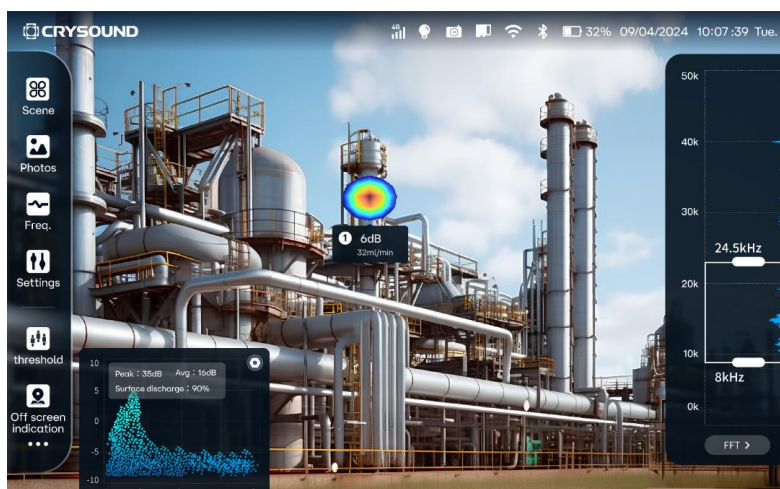

After clicking on the icon in the top right corner of the graph, you can select the PRPD graph display.

On the main interface, clicking on "Function Settings" will take you to the function parameter settings page. In the "Acoustic Parameters" section, select "Partial discharge".

Users can set the frequency of the tested power grid according to its operating frequency, with a default value of 50 Hz.

## Mechanical scenario

When the camera is operating in the "Mechanical scenario", it can capture mechanical vibration sound signals and display the source location on the screen. It also has vibration analysis capabilities.



After clicking on "Freq.", you can choose between multiple frequency points or a single frequency point. When selecting multiple frequency points, the right side of the main interface will display five frequency checkboxes. Clicking on "40kHz" can activate/deactivate the 40kHz frequency point (up to four frequency points can be deactivated). Dragging the frequency checkboxes up and down can adjust the size of the frequency points. Finally, all the source locations of the frequency points will be displayed on the screen by superimposing them. When selecting a single frequency point, you can change the position of the frequency point by dragging.

On the main interface, clicking on "Function Settings" will take you to the function parameter settings page. In the "Acoustic Parameters" section, select "Mechanical".

## 6.5 Frequency

In the "General scenario" and "Gas leak scenario", you can select pre-set frequencies. By default, the 20kHz~30kHz range is selected.

Users can create their own frequency ranges using the following steps:

1. Slide the frequency checkboxes to the desired frequency range.
2. Go to the "Freq." selection interface and click on the "+" icon. This will add the new frequency range to the frequency list.
3. To delete a specific frequency range, click on the "🗑️" icon next to it.

When operating in the "Mechanical scenario", the frequencies switch to the multi-frequency point mode. The default frequency points are 10kHz, 20kHz, 30kHz, 40kHz, and 60kHz, with a frequency bandwidth of 2kHz. You can also select a single frequency point with a default frequency of 20kHz and a bandwidth of 2kHz.

Users can also create new multi-frequency point and single-frequency point frequency ranges using similar steps as mentioned above:

1. Slide the frequency checkboxes to the desired frequency range.
2. Go to the "Freq." selection interface and click on the "+" icon. This will add the new frequency range to the frequency list.
3. To delete a specific frequency range, click on the "🗑️" icon next to it.

## 6.6 Function settings

### Acoustic parameter settings

#### Imaging Points

Sets the maximum number of imaged sound sources in the detection screen. For example, when set to 3, the test interface displays the sound pressure of 3 sound sources.



### **Acoustic palette**

Sets the color scheme for the sound cloud image in the detection screen. Users can choose from options such as rainbow color, iron red, or iron gray.

### **Dynamic range**

When imaging points are greater than 1, increasing the dynamic range allows for the detection of sound sources with varying sound pressures.

### **Focus**

Enabling the focus function allows for the detection of minor leaks. When detecting partial discharges, enabling the focus function enhances the accuracy of discharge type identification.

### **Focus shielding**

When Focus Shielding is enabled, the areas outside the focus region will not display the acoustic image. When Focus Shielding is disabled, the areas outside the focus region will display the acoustic image.

### **Steady**

Enabling the steady-state function enhances anti-interference capability and stabilizes imaging. Disabling it allows for the detection of transient sound signals.

### **Off-screen indication**

Enabling the extended field of view allows sound sources outside the display screen area.

### **Advanced settings**

Clicking on advanced settings opens a dialog box with additional advanced parameters.

### **Monitoring**

Users can enable or disable the ultrasonic monitoring function. When enabled, the ultrasonic signals can be heard through headphones.

### **Imaging threshold**

Sets the minimum sound pressure for the device to display the tested sound source on the screen. Only sound sources with sound pressures greater than the threshold will be displayed.

### **Measurement bandwidth**

Selects a test frequency range of either 2kHz100kHz or 2kHz50kHz.





**Note:** Please keep in mind that some glossary related to specific devices or software may vary, and the translation provided here is a general representation of the acoustic parameter settings.

## **Thermal parameter settings**

### **Thermal palette**

Allows selection of the thermal imaging color palette, such as rainbow color, white-hot, black-hot, iron red, iron gray, or high-resolution rainbow.

### **Temperature scale**

Sets the range of temperatures for measurement and display. The default temperature range is  $-20^{\circ}\text{C}$  to  $120^{\circ}\text{C}$ .

### **Temperature unit**

Allows switching between Celsius ( $^{\circ}\text{C}$ ), Fahrenheit ( $^{\circ}\text{F}$ ), or Kelvin (K) as the temperature unit for measurement and display.

### **Distance**

Allows input of the testing distance during measurements.

### **Emissivity**

Sets the emissivity value for the infrared device. By setting the appropriate emissivity value, more accurate temperature measurements can be obtained. Different materials have different emissivity values.



### Thermal correction

Allows adjustment of temperature correction for the thermal module.

### Ambient temperature

Allows input of the ambient temperature during measurements.

### Background Temperature

Allows input of the background or reflected temperature during measurements.

**Note:** Please note that the available options and glossaries may vary depending on the specific infrared device or software being used.

## Create a new scenario

Users can create new scenarios by following these steps:

1. Click "▼", open the scene creation window.
2. Click "⊕" and choose "Gas".
3. Enter a name to complete the creation of the gas leak scenario.
4. Click "✎" to modify the test scenario name.
5. Click "✕" to save changes and exit the scene editing window.
6. Click "🗑️" to remove the currently selected test scenario.

## 6.7 Photos

After clicking the "Photos" button, a gallery popup window appears. Select an album, and the photos and videos taken will be saved to the selected album.

### Album creation

Users can create a new album following these steps:

1. Click "⊕" to create a new album.
2. After entering a name, click the "✎" button to enter the album into editing mode.
3. Click the "🗑️" button to remove the album and its contents.

After clicking "Library" you'll enter the "Gallery view" interface.

### Personal collection

Click "Favorites" to view the user's favorite photos and videos.

### Search

Click "Search" to enter the search interface. Users can input time, location, album names, and tag information in the search box to find data.

### Select



Click "Select" to enter multi-selection mode. Users can choose multiple photos and videos, then click the  button to remove them.

Click on an image to enter the image viewing interface. Tap the screen to reveal the photo's name and tag button.

### Image favoriting

Click "★" to add the photo to favorites.

### Image deletion





Click  to remove the photo.

### Tags

Click  to bring up the tag information input interface. Users can input information about the tested equipment.



### Voice tagging

Users can setup a voice tagging using the following steps:

1. Click  to open the voice tagging interface.
2. Click  to start recording, then click  to end the recording. After recording, click  to listen (headphones required), or click  to remove the recording.
3. Click "X" to save the voice tag.

### Image tagging

Users can setup image tagging using the following steps:

1. Click  to open the photo tagging interface.
2. Click "+" to enter the camera interface. Supports up to 4 photos. Press "○" to take a photo. Click  to remove the captured photo.
3. Click "X" to save the image tag.

### Text tagging

Users can setup a text tagging using the following steps:

1. Click "T" to open the text tagging interface.
2. Tap the input box and use the keyboard to enter text content. Edit the text information using the keyboard.
3. Click "X" to save the text tag.

## 6.8 Custom tools

The default custom tools are "Imaging points" and "Off-screen indication". Click the "⋯" button to modify the tools in the popup toolbar editing interface.

Users can modify custom tools using the following steps:



1. Click "⊖" next to the tool under "Show on navigation bar" to remove the corresponding tool.
2. In the "More" section, select the tools you want to add. Click the "⊕" button next to the tool parameter on the left to add it to the toolbar.
3. Click "✕" to save and exit the toolbar editing.

## 6.9 Dropdown menu

Pull down from the top edge of the display area to open the dropdown menu interface.

### Wi-Fi

Click "📶" to toggle Wi-Fi on or off. Long-press to enter Wi-Fi settings.

### Bluetooth

Click "📶" to toggle Bluetooth on or off. Long-press to enter Bluetooth settings.

### Hotspot

Click "📶" to toggle the hotspot on or off. Long-press to enter hotspot settings.

### Location

Click "📍" to toggle the location on or off. Long-press to enter location settings.

### Light

Click "💡" to toggle the LED light on or off.

### Low power mode

Click "🔋" to toggle low power mode on or off.

### Auto brightness

Click "☀️" to toggle auto brightness on or off. Long-press to enter display settings.

### Brightness

Slide the bar to the right of "☀️" to adjust the backlight brightness of the display and disable auto brightness.

### Volume



Slide the bar to the right of "🔊" to adjust the volume of the headphone jack.

## 6.10 System settings

### Bluetooth settings







After entering the system settings interface, navigate to the Bluetooth® settings. The camera's Bluetooth name is CRY8124. Users can connect devices with Bluetooth using the following steps:

1. Click the "" button to turn Bluetooth on or off.
2. Click " Refresh" to update the list of available Bluetooth devices.
3. Click on a Bluetooth device in the list to pair it. A pairing confirmation popup will appear; click "Pair" to complete the pairing process and connect the Bluetooth device.
4. Click " > " to view the details of a connected Bluetooth device. Click "" to remove a connected Bluetooth device. Click "X" to save and exit.

## Wi-Fi settings

Clicking "Wi-Fi Settings" will take you to the Wi-Fi settings interface. Users can connect devices with Wi-Fi using the following steps:

1. Click the "" button to turn Wi-Fi on or off.
2. Click " Refresh" to update the list of available Wi-Fi devices.
3. Click on a Wi-Fi device in the list to connect to it. A password input interface will appear; enter the password and click "OK" to connect to the Wi-Fi.
4. Click " > " to view the details of a connected Wi-Fi device. Click "" to remove a Wi-Fi device. Click the "" switch to automatically connect to this Wi-Fi device on device startup. Click on the password to view the current password of the Wi-Fi device.
5. In the IPV4 settings, you can view network information and choose between automatic IP configuration or manual IP configuration.
6. Click "X" to save and exit.

## Hotspot settings

Clicking "" will take you to the hotspot settings interface. Users can a hotspot connection using the following steps:

1. Click the "" button to turn the hotspot on or off.
2. Click "Name" to modify the device name.
3. Click "Password" to modify the device password.
4. Click "X" to save and exit.

**Note:** Hotspot functionality and Wi-Fi cannot be enabled simultaneously, the device can only operate in one of these modes.

## Display and brightness

Clicking "Display and brightness" will take you to the display and brightness settings interface.

1. In the theme selection, you can choose between dark and light themes.



2. In brightness, you can adjust the brightness of the current display (0% to 100%).
3. Click the "" button to turn on automatic brightness, which adjusts the brightness according to ambient light.
4. Click "X" to save and exit.

## Date and time

Clicking "Date and time" will take you to the time and date settings interface. Users can setup the date and time using the following steps:

1. Click "" to enable automatic time synchronization. When connected to the internet, the device will automatically adjust its time to internet time.
2. In the time zone section, click "▼" to choose your time zone.
3. In the date settings, you can modify the date.
4. In the time settings, you can modify the time.
5. In the date format, you can set the display format to year-month-day, month-day-year, or day-month-year.
6. Click "X" to save and exit.

## Language and region

Clicking "Language and region" will take you to the language settings interface. Users can adjust the language by following these steps:

1. Click the "▼" button next to "Preferred Language" to choose your language.
2. Click "X" to save and exit.

## Low energy settings

Click "Low energy Settings" to enter the low power settings interface. Users can setup low energy settings using the following steps:

1. Click "▼" on the right side of "Auto Sleep Time" to select how long the device should wait before going to sleep when not in use.
2. Click "▼" on the right side of "Auto Shutdown Time" to select how long the device should wait before shutting down after being asleep.
3. Click "X" to save and exit.

## About

Clicking "About" will take you to the device information interface. In this interface, you can view information about the device.

## Software update

Clicking "Software update" will take you to the software update interface, where you can view the current software version of the device.



## Software & system update

Follow these steps for an offline update:

1. Download the firmware to your PC.
2. Place the firmware in the "Update" folder in the TF card, or connect the device to your PC via USB-C cable, open the "CRY8124" disk, and place the firmware in the "Update" folder.
3. Navigate to "System Settings" > "Software Update" interface. Click on "Check for Updates," prompting a window to select the firmware package.
4. Choose the firmware, then click "OK" to start the software update process.
5. Wait for the device to restart. Once restarted, return to "System Settings" > "Software Update" to confirm the software version.
6. Click "✕" when finished.

## Restore factory setting

Clicking the "Restore Factory Settings" button, a window will pop up asking if you want to restore factory settings. Clicking "Yes" will proceed to the next step, "Clear all data?" Clicking "Yes" will erase all photos and videos and restore the acoustic and infrared parameters. Clicking "No" will only restore the acoustic and infrared parameters.

## Calibration

Clicking "Calibration" will take you to the instrument calibration interface.

### Calibration expiration date

Displays the duration of the device calibration validity. Contact the manufacturer for calibration the exceeds this period.

### Certificate of calibration

Users can view the certificate of calibration using the following steps:

1. Clicking "Details >" on the right side of the calibration certificate will take you to the calibration certificate preview interface, where you can view the electronic version of the device's calibration certificate.
2. Clicking "✕" will exit the calibration certificate preview interface.
3. Click "✕" to exit.

## Help

Clicking "Help" will take you to the help interface.

## User Manual



Users can view the user manual following these steps:

1. Clicking "**Details >**" on the right side of the user manual will take you to the user manual preview interface, where you can view the electronic version of the user manual.
2. Clicking "**X**" will exit the user manual preview interface.
3. Click "**X**" to exit.

## Aftersales

Click on "Aftersales " and you will be directed to the after-sales maintenance interface.

## Warranty

Displays the range of time covered by the device's warranty. Users can view the certificate of quality using the following steps:

1. Click on the right side of the quality certificate "**Details >**" to enter the quality certificate preview interface and view the electronic version of the quality certificate.
2. Click on "**X**" to exit the quality certificate preview interface.
3. Click "**X**" to exit.

## Microphone test

Clicking "Microphone Test" will take you to the microphone self-test interface. Users can start the microphone test using the following steps:

1. Click on "Start test" to initiate the microphone test.
2. After the test is completed, review the microphone test results. If any damaged microphones are detected, please contact the manufacturer for repair.





## 07 Usage tips

### 7.1 Capturing sound source

Observe the frequency spectrum graph for any prominent signals or peaks. If such signals exist, adjust the frequency band to encompass the frequency range where the prominent signal or peak is located. Then, observe if any sound sources appear in the display.

Try adjusting the dynamic range to relatively larger values. This allows for capturing multiple sound sources with similar sound pressure levels simultaneously. In scenarios where there are significant differences in sound pressure levels among multiple sound sources in the display, smaller dynamic range parameters may result in larger sound sources overshadowing smaller ones.

### 7.2 Eliminating reflection interference

If you are not unsure whether the sound cloud image in the display is the actual source or a reflected virtual image, you can try capturing the sound source from different angles. If the sound source is captured from multiple angles, it is likely the actual source location. Reflected sound sources may exhibit position shifts or even disappear at different angles.

### 7.3 Eliminating interference noise

Low-frequency ranges are susceptible to environmental noise interference. Depending on the characteristics of the sound source, it's advisable to use the mid to high-frequency ranges to pinpoint the location of the sound source effectively.

Select a relatively narrow frequency band range for locating the sound source. This helps to eliminate interference noise from other frequency bands.

### 7.4 Equipment maintenance

Keep the acoustic sensor ports clean to prevent dust buildup, when there is dust in the acoustic sensor ports, gently blow air to clean them, and do not use a wet cloth for cleaning.

When the device is not in use for a long time, fully charge the device, then place it in its original packaging, and store it in a dry environment at room temperature.

Regularly checking and replenishing the device's battery can effectively prolong its lifespan.



## 08 Contact us

### 8.1 Hangzhou headquarters

Tel: +0086-0571-88225198, +0086-0571-88225128

E-mail: [info@crysound.com](mailto:info@crysound.com)

Add: No.10, Xianqiao Road, Zhongtai Street, Yuhang District, Hangzhou, Zhejiang Province, China

Web: [www.crysound.com](http://www.crysound.com)

### 8.2 Dongguan branch

Tel: +0086-0769-21688120

E-mail: [info@crysound.com](mailto:info@crysound.com)

Add: 7F, B1 Bldg, Songhu Lake, Intelligent Valley, Liaobu Town, Minfu Rd, Dongguan City, Guangdong Province, China

Web: [www.crysound.com](http://www.crysound.com)

### 8.3 Houston Office

Tel: +001-(877) 215-7752

E-mail: [info@crysound.com](mailto:info@crysound.com)

Add: 13777 Stafford Point Dr, Stafford, TX 77477, US

Web: [www.crysound.com](http://www.crysound.com)





**Empowering 100+ industries  
through acoustic testing technology**

make the world safer, greener and more efficient!